

Constructive Features

- cooking vessel in stainless steel AISI 304 (bottom thickness 12 mm and wall thickness 3 mm). Vessel with electric tilting on front part
- insulated lid with double cover in stainless steel AISI 304, with ergonomic handle, balanced by means of gas springs
- self-supporting frame in stainless steel AISI 304 (thickness 30-40/10)
- outer cover in stainless steel AISI 304, fine satin finish (thickness 12-15/10)
- adjustable feet in stainless steel AISI 304 to ensure levelling, with removable cover for cleaning operations
- fast accessibility to the main functional parts (electronic card, fuses, thermostats...) only removing the frontal panels
- protection level IPX5

Functional Features General

- heating by means of steam (from user s system), controlled by electronic board
- safety valve at 9 bar and analogic pressure gauge
- temperature control by system with two probes (product/bottom)
- automatic mixing device with three arms and PTFE scrapers, completely removable to make cleaning easier, with regulation directly from the control panel according to the product to be processed
- electronic control by means of multifunctional keyboard with Touch Screen 7" and easy and clear messages
- USB connection to download HACCP data, update the software and load cooking programs
- ability to interrogate the machine using communication protocol MODBUS over RS485 serial interface

Panel Board Functions

- ON/OFF switch
- resistive 7" touch screen
- keys to turn on/off the mixer and move basin
- selection of 5 different cooking modes, with working temperature setting
- cooking type and time setting
- cooking in "Manual" mode
- cooking in "Program" mode
- creating and editing multiphase cooking programs, setting for each phase: cooking type; cooking parameters (temperature and time); mixer settings and possibility to insert text messages
- speed setting/adjustment (clockwise and counterclockwise) rotation times and mixer pause times
- possibility to activate mixer at minimum speed during tank tilting to facilitate product pouring
- tank water load setting (hot up to 90° C/cold) with automatic liter measurements
- control for tilting and return of cooking tank from Touch Screen or keyboard
- delayed cooking setting with date, time, and programming cycle
- language settings touch Screen
- input of different units of measurement (° C/° F ; Liters/gallons ; etc)

Display/Signal

- display type of cooking, temperature probes used and set temperature
- heating operating visual alarm
- time to end of cycle display
- display tank out of position for cooking
- audible/visible warning of mixer program start
- signaling tap position, managing water in the tank
- signal of lid and cock position during vat tilting
- self-diagnostics

Safety System

- emergency button
- double-jacket safety valve
- heating interruption during vat tilting



Optionals

- CADE0010 - CLEANING SHOWER FOR CBT/PR
- DAPC0230 - SOCKET OUTLET 230V 2P+T 16A
- D150 - KIT WHEELS PR/CBT/DBR
- CAPV1020 - EXTRA SCRAPER VERTICAL MIXER CBT130

Accessories

- CAPM0010 - ADJUSTABLE PADDLE KIT (2 pcs)

Certificates



Planner

.....

.....

.....

.....

.....

.....

.....

.....

.....

.....

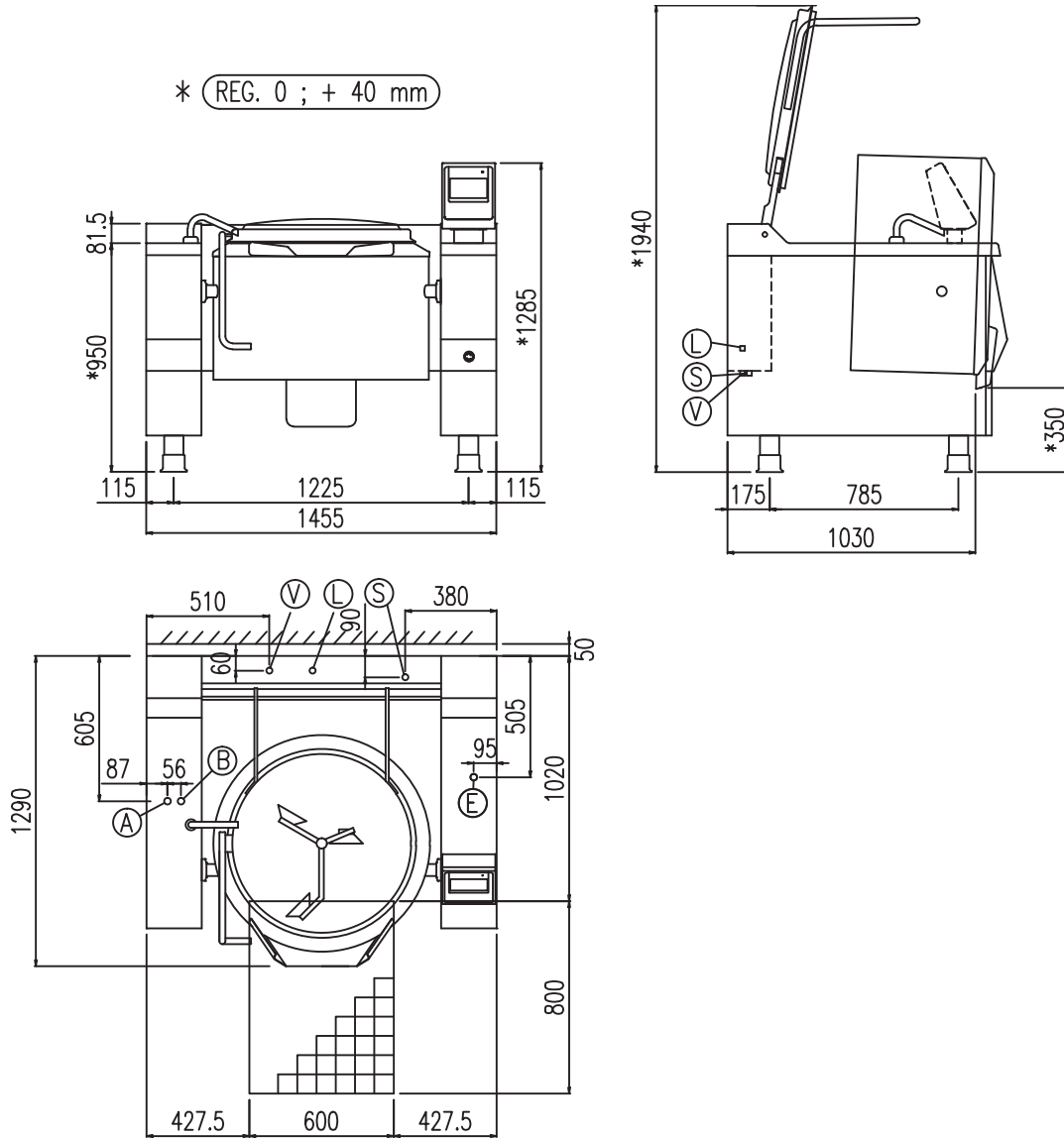

Dimensions weights and capacities

Width	1455 mm	Vessel diameter	700 mm	Cooking vessel surface	38 dm ²
Depth	1290 mm	Vessel height	400 mm	Weight	430 kg
Height	1030 mm	Capacity	130 lt		

Mixer

Mixer torque	191 Nm	Mixer power	0,37 Kw	Mixing speed	6-18 Rpm
--------------	--------	-------------	---------	--------------	----------

Water connection

Water pressure	50÷300 KPa	Cold water inlet (B)	3/4"	Hot water inlet (A)	3/4"
----------------	------------	----------------------	------	---------------------	------

Steam connection

Steam connection (V)	3/4"	Condensate drain (S)	3/4"	Steam pressure	8 bar
Steam load	70 kg/h	Steam flow to keep boiling	--- kg/h	Steam consumption (from 20°C to 100°C)	20 kg
Compressed air connection (L)	6 mm	Air pressure (L)	6 Kpa		

Electrical connection

STD Voltage (E)	220-240V 1N ~ 50/60Hz	Electric power	0,60 Kw	Current	--- A
OPT Voltage (E)	208V 2 ~ 50/60Hz	Electric power	0,50 Kw	Current	--- A
OPT Voltage (E)	208V 1N ~ 50/60Hz	Electric power	0,50 Kw	Current	--- A
OPT Voltage (E)	460-480V 3 ~ 50/60Hz	Electric power	0,60 Kw	Current	--- A
OPT Voltage (E)	440V 3 ~ 50/60Hz	Electric power	0,60 Kw	Current	--- A
OPT Voltage (E)	380-415V 3 ~ 50/60Hz	Electric power	0,60 Kw	Current	--- A
OPT Voltage (E)	220-240V 2 ~ 50/60Hz	Electric power	0,60 Kw	Current	--- A